

RT 55 / PD
55 LBS THRUST
12 VOLT 50 AMPS
48" SHAFT

for use with "K" serial numbers

2-year warranty from the date of purchase

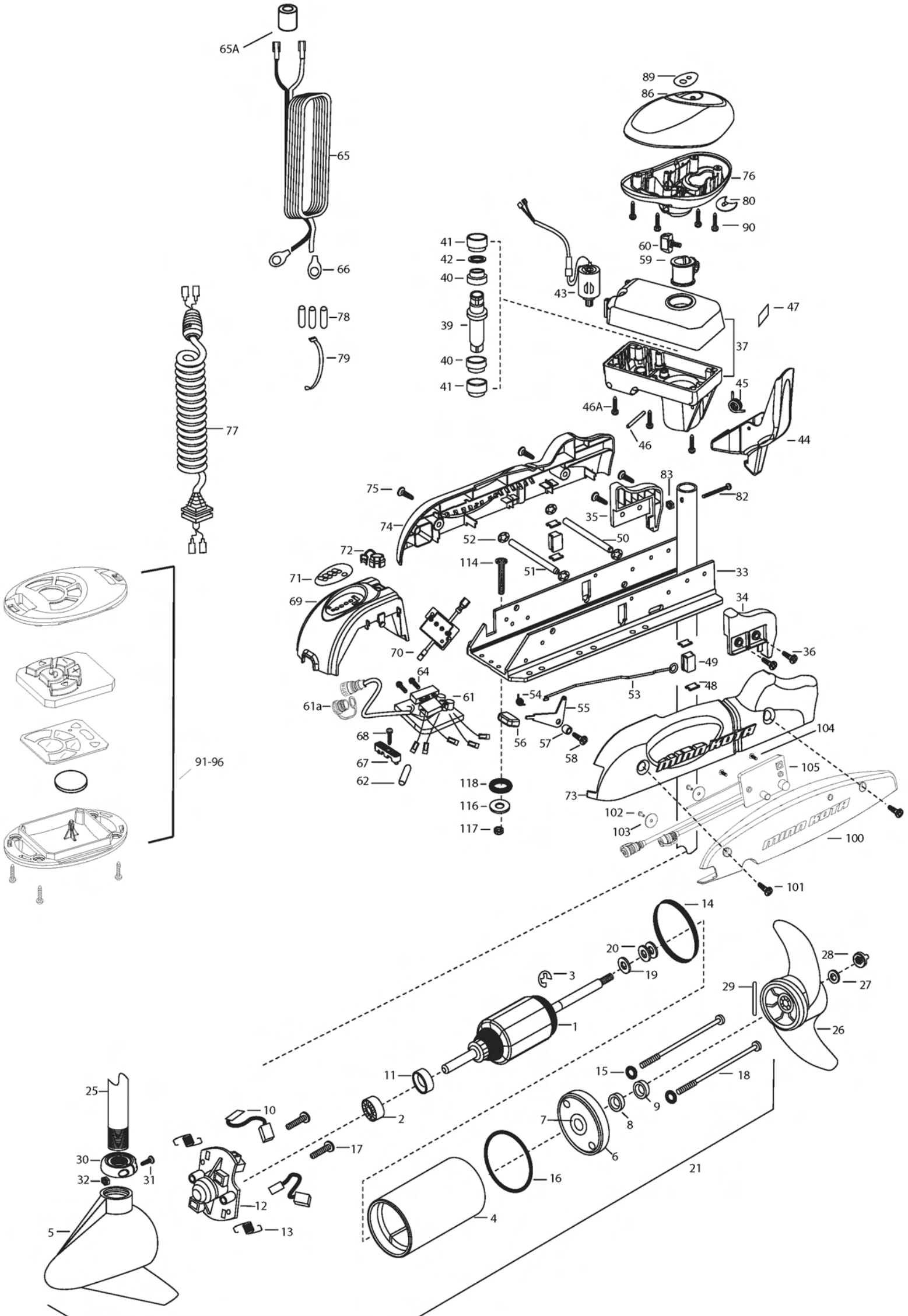

1	2-100-117	ARMATURE ASSEMBLY 12V VARS TXT	*42	2304603	O-RING	79	2256300	TIE WRAP-5" BLACK
2	140-010	BALL BEARING	43	2307050	MOTOR- DRIVE HOUSING HIGH SPD	80	2224703	INSERT- PLUG WHITE
3	788-015	RETAINING RING	44	2307201	LATCH HANDLE PD/AP	82	2332102	SCREW-10-24 X 1-3/4
4	2-200-301	HOUSING ASSEMBLY CENTER 3.62 TXT	45	2302750	SPRING- LATCH TORSION PD/AP	83	2333101	NUT-HEX 10-24 NYLOC
5	421-336	HOUSING -BRUSH END 3.62 TXT	46	2302628	PIN- ROLL 3/16X2 SS	86	2300243	CONTROL BOX COVER- RIPTIDE WHITE
6	2-400-337	PLAIN END HOUSING ASSEMBLY 3.625	46A	2303405	SCREW - DRIVE HOUSING [6 EA]	89	2315689	DECAL- COVER 55pd
7	144-049	BEARING - FLANGE (SERVICE ONLY)	47	2305564	DECAL-STOW/DEPLOY	90	2372100	SCREW-8-18 X 5/8 THD CUT [4.EA]
8	880-003	SEAL	48	2335110	PAD-PIVOT SUPT [4.EA]			
9	880-006	SEAL WITH SHIELD	49	2305103	PIVOT PAD- NEW MTR'L [2.EA]	■	2994020	COPILOT TRANSMITTER
10	188-036	BRUSH ASSEMBLY [2.EA]	50	2330510	PIN-LATCH PD BASE SS	91		CASE, COVER, TRANSMITTER
11	725-050	BRUSH RETENTION- PAPER TUBE	51	2330520	PIN-PIVOT PD BASE SS	92		KEYPAD
12	738-036	BRUSH PLATE W/HOLDER	52	2333100	NUT-SPEED [4.EA]	93		CIRCUIT BOARD, TRANSMITTER
13	975-040	SPRING - TORSION [2.EA]	53	2303612	ROD-RELEASE RT/AP S	94		BATTERY, COIN
14	337-036	GASKET	54	2322700	SPRING-RELEASE LEVER	95		CASE, BOTTOM, TRANSMITTER
15	701-008	O-RING, THRU-BOLT [2.EA]	55	2333705	LEVER-RELEASE SS	96		SCREW, TRANSMITTER [4EA]
16	701-081	O-RING	56	2300101	RELEASE-KNOB	■	2994089	RECEIVER ASSEMBLY V2, COPILOT
17	830-007	SCREW-8-32 [2.EA]	57	2301700	SPACER-RELEASE LEVER	100	2372511	CASE, RECEIVER WHT
18	830-042	THRU-BOLT 10-32X8.83 [2.EA]	58	2332104	SCREW-1/4-20 X 5/8 SS	101	2373442	SCREW 1/4-20 X 1.75 SS [2EA]
19	990-067	WASHER- STEEL THRUST	59	2031522	COLLAR- DRIVE (W/INSERT)	102	2373450	SCREW #8 X 3/8 [2EA]
20	990-070	WASHER - NYLATRON [2.EA]	60	2011366	SCREW-COLLAR/NEW KNOB SS	103	2371727	WASHER [2EA]
21	2097095	MOTOR ASSEMBLY 12V 3.62 48"	60A	2323104	NUT	104	2373418	SCREW #8 X 5/8 SS
25	2032021	TUBE-CARBON COMPOSITE WHT 48"	61	2304060	CONTROL BOARD ASSEMBLY- 12V PD	105	2374089	CIRCUIT BOARD V2, RECEIVER
■	1378131	PROPELLER KIT	61a	2320208	DUST PLUG	■	2994864	BAG ASSEMBLY- (BOLT,NUT,WASHERS)
26	2091160	PROPELLER W/WEDGE 2	62	2355410	SHRINK TUBE-3/8 ODX2	*114	2263462	BOLT-MOUNTING-1/4X2 W/STG [6.EA]
27	2151726	WASHER-5/16 SS	64	2303434	SCREW-8-32 X 5/8 [3.EA]	*116	2261713	WASHER-1/4 [6.EA]
28	2198400	ANODE- ZINC 3.25/3.625 LWR U	65	2090651	LEADWIRE IOGA 44"	*117	2263103	NUT NYLOK 1/4-20 MTG [6.EA]
29	2092600	PIN-DRIVE	65A	2307310	BEAD - FERRITE (CE MODELS ONLY)	*118	2301720	WASHER-MOUNTING RUBBER [6.EA]
30	2301545	COLLAR- LATCH PD/AP	66	2020700	TERMINAL RING [2.EA]			
31	2303434	SCREW- 8-32X5/8 MACH PHCR	67	2321310	STRAIN RELIEF- BRACKET PD/AP	■	2888460	SEAL & ORING KIT
32	2303112	NUT 8-32 NYLOC SS	68	2323405	SCREW-1/4-20 X 5/8 SS			
33	2301937	EXTRUSION- BASE MACHINED	69	2306556	HOUSING- CENTER PD/AP WHIT			
34	2303932	MOTOR REST- RIGHT 3-5/8	70	2074080	BATTERY GAUGE - 12 VOLT			
35	2303937	MOTOR REST- LEFT 3-5/8	71	2316606	DECAL- BATT GAUGE H RT AP			
36	2332104	SCREW 1/4-20X5/8 SS SELF TAP [4.EA]	72	2302935	STRAIN RELIEF-DR. HOUSING			
37	2771827	DRIVE HOUSING / LATCH HANDLE WHITE	73	2303944	SIDEPLATE (RIGHT) WHITE			
■	2882011	BUSHING/ OUTSHAFT KIT (INCLUDES 39-42)	74	2303949	SIDEPLATE(LEFT) WHITE			
			75	2332104	SCREW-1/4-20 X 5/8 SS			
*39	2302010	DRIVE HOUSING OUTPUT SHAFT	76	2302516	CONTROL BOX WHT			
*40	2307304	BUSHING- INNER [2.EA]	77	2991280	COIL CORD WSTRAIN RELIEF 48, 54"			
*41	2307305	BUSHING- OUTER [2.EA]	78	2065400	WIRE INSULATOR-LGE 1-3/4 [3.EA]			

* This item is part of an assembly. This item cannot be sold separately due to machining and /or assembly that is required.

P/N 2314951

REV. Q

ECN 31554

8-09

Riptide 55 is 12-volt only!

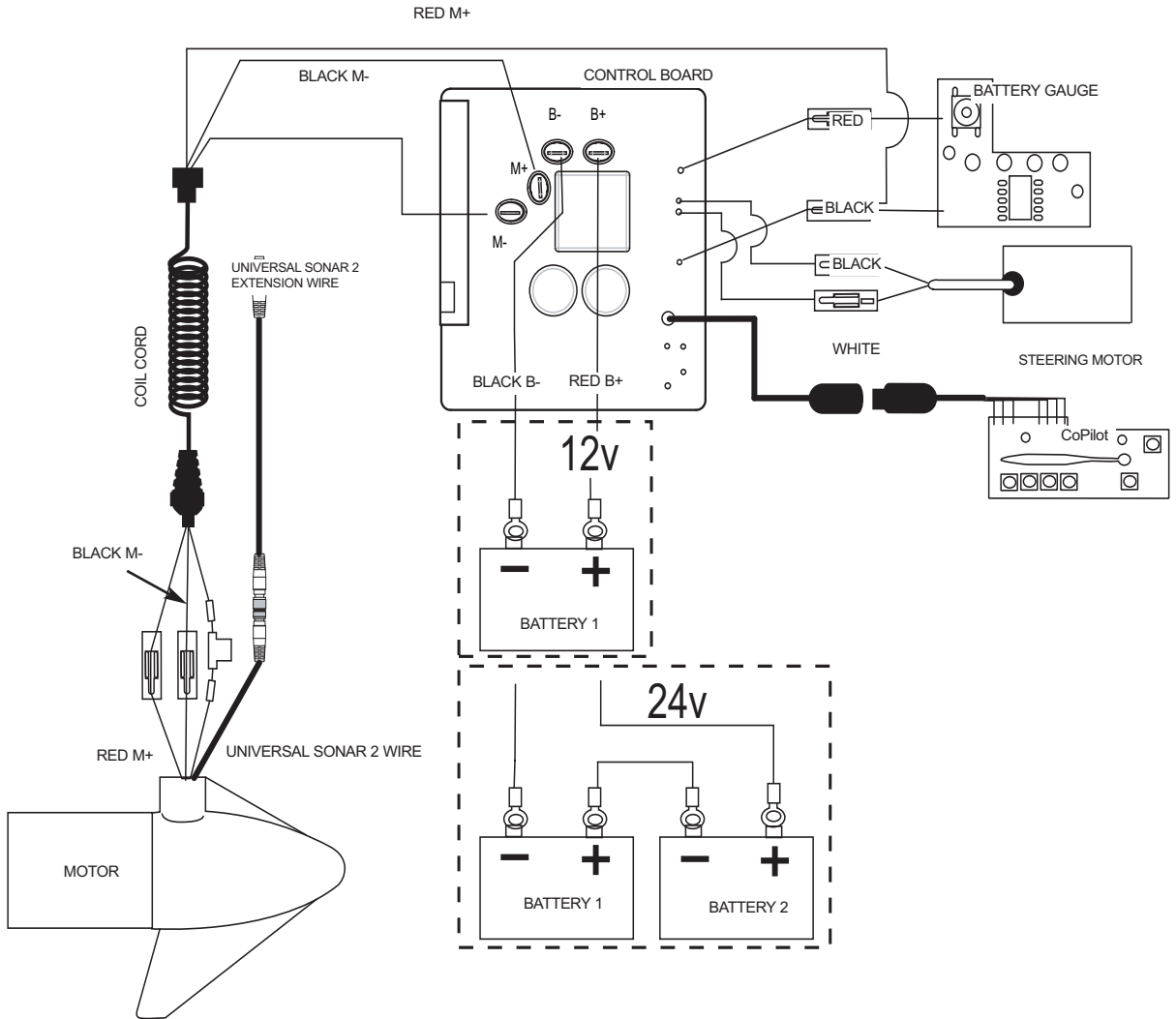

NOTE:
1. BATTERY 2 AND CONNECTING WIRE USED FOR 24V APPLICATIONS ONLY
2. UNIVERSAL SONAR 2 WIRES APPLICABLE TO US2 MOTORS ONLY