

RIPTIDE MOTORS
RT80SM/BG
80 LBS THRUST
24 VOLT 56 AMPS
52" SHAFT

for use with "K" serial numbers
2-year warranty from the date of purchase

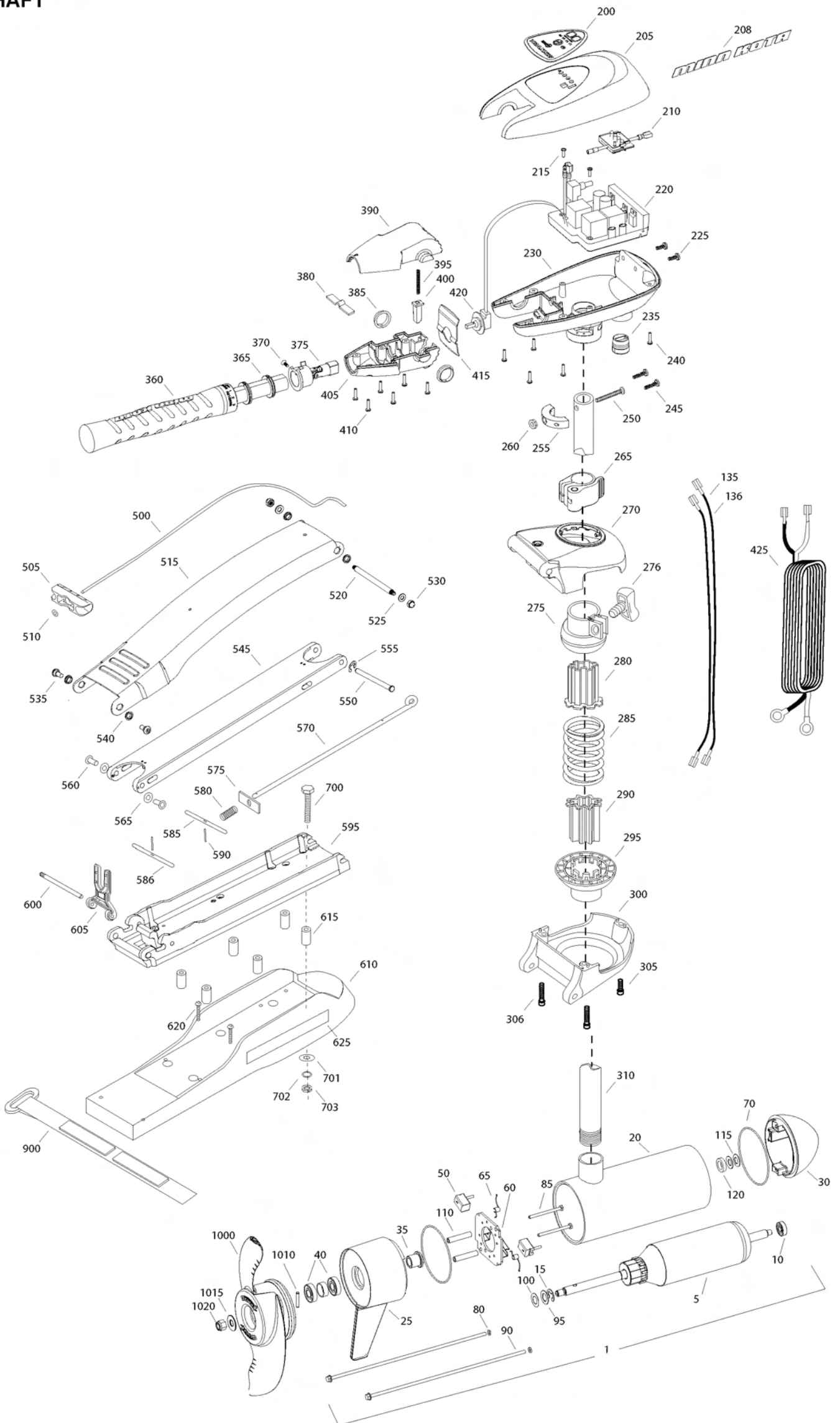

Item	P/N	Description	Qty	Item	P/N	Description	Qty	Item	P/N	Description	Qty	Item	P/N	Description
1	2316228	24V Motor 52" SW	1	■	2990957	Handle assy, VARS [360-410]	1							
5	2-100-214	Armature assembly	1	360	2990456	Grip/handle assy, VARS [360-375]	1	■	1378132	Propeller kit WW2				
10	140-010	Bearing	1	365	2060015	Bearing, handle	2	■	2994876	Propeller bag assy				
15	788-040	Retaining ring	1	370	2063405	Screw, #6 PFH SS	1	1000	2331160	Propeller WW2	1			
20	2-200-397	Center housing assembly	1	375	2884092	Yoke / spider assy, VARS	1	1010	2262658	Drive pin, large	1			
25	2-300-340	Brush end housing assembly	1	380	2302742	Spring, detent, off	1	1015	2091701	Washer, prop, large	1			
30	421-376	Plain end housing assembly STD	1	385	2060005	Bearing, handle pivot	2	1020	2198401	Nut, nylock, prop, Anode	1			
35	144-017	Flange bearing	1	390	2060900	Handle pivot, top	1							
40	880-025	Seal	2	395	2302745	Spring, release button	1							
50	188-094	Brush	2	400	2063700	Button, release	1							
60	9-738-004	Brush plate assembly	1	405	2060905	Handle pivot, bottom	1							
65	975-041	Brush spring	2	410	2303412	Screw, #6 x 5/8 SS	6							
70	701-043	O-ring, motor	2											
80	701-009	O-ring, thru-bolt	2	415	2062715	Spring, handle pivot	1							
85	830-027	Screw, 10-32 x 2	2	420	2061700	Washer, pot holder	1							
90	830-094	Thru-bolt	2	425	2992523	Leadwire assy	1							
95	990-051	Washer, steel	2											
100	990-052	Washer, nylatron	2	■	2991845	Mount, Bow Assy bow guard	1							
110	973-025	Spacer, brush plate	2			[500-625]								
115	992-010	Washer, Belleville	2	500	2251601	Rope	1							
120	990-045	Spacer, thrust	1	505	2150400	Pull grip	1							
135	640-018	Leadwire, black	1	510	2151700	Washer	1							
136	640-123	Leadwire, red	1	515	2264244	Arm, upper, std, sw	1							
■	2889460	Seal and O-ring Kit		520	2262604	Pin, bowguard, upper	1							
				525	2261722	Washer, 5/16", ss	2							
200	2195659	Decal, c-box cover	1	530	2223100	Nut, 5/16-18 SS	2							
205	2060296	C-box cover	1	535	2263500	Bolt, shoulder	2							
208	2325666	Decal - MinnKota	2	540	2293501	Bushing, SS	4							
210	2074081	Battery meter, 24v SW	1	545	2994351	Arm, Lower, std, sw	1							
215	3043427	Screw, #8 x 7/8 SS	2	550	2262622	Pin, clevis ss	1							
220	2184007	Control board, 24/36v	1	555	2263011	E-clip, ss	1							
225	2303434	Screw, #8-30 x 5/8 SS	2	560	2267318	Bushing, nyloner	2							
230	2062503	Control box, VARS, SW	1	565	2261708	Washer, spacer, .010 thk	as reqd							
235	2062905	Strain relief	1	570	2153603	Eyeshaft, ss	1							
240	2303412	Screw, #6 x 5/8 SS	6	575	2262703	Spring stop	1							
245	2263434	Screw, #8 x 1 SS	2	580	2152701	Spring, lock bar, ss	1							
250	2263406	Screw, #10-24 x 2 SS	1	585	2233621	Lock bar, front, ss	1							
255	2061517	Collar, c-box	1	586	2233623	Lock bar, back, ss	1							
260	2333101	Nut, 10-24, nylock, SS	1	590	2152612	Spring pin, ss	2							
265	2991521	Cam lock/depth collar assy	1	595	2773983	Bowplate w/ insert, std, sw	1							
				600	2260505	Hinge pin, ss	1							
■	2991764	Bowguard Assembly SW [270-306]	1	605	2293811	Yoke, Max	1							
270	2991779	Bracket, top	1	610	2263917	Motor rest, std, sw	1							
275	2261525	Spring sleeve, Upper	1	615	2261505	Spacer, motor rest	6							
276	2011366	Knob, collar, ss	1	620	2263434	Screw, #8, SS	2							
280	2264702	Tube insert, bowmount	2	625	2065677	Decal, motor rest	2							
285	2262705	Spring, bowguard	1											
295	2261535	Spring sleeve, Lower	1	■	2994830	Bag assembly	1							
300	2991777	Bracket Assy, bottom	1	700	2263431	Screw, 1/4-20 x 3 1/2" PPH, SS	6							
305	2263422	Screw, 5/16 x 1" SHCS ss	1	701	2301720	Washer, rubber mounting	6							
306	2263424	Screw, 5/16 x 2.5" SHCS ss	2	702	2261713	Washer, 1/4 SS	6							
				703	2263101	Nut, 1/4-20 Nylock, SS	6							
310	2032034	Tube Composite 52"	1											
				900	2263804	Strap, hold down	1							

* This item is part of an assembly. This item cannot be sold separately due to machining and /or assembly that is required.

Riptide 80 is 24-volt only!

THIS IS A UNIVERSAL MULTI-VOLTAGE DIAGRAM. DOUBLE CHECK YOUR MOTORS VOLTAGE FOR PROPER CONNECTIONS

